

Assembly Instruction

Step 3

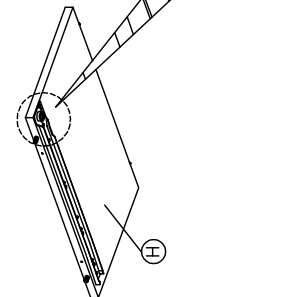

Step 4

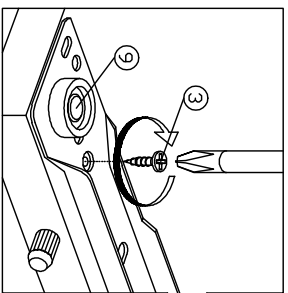
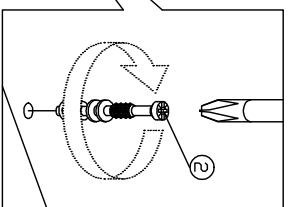
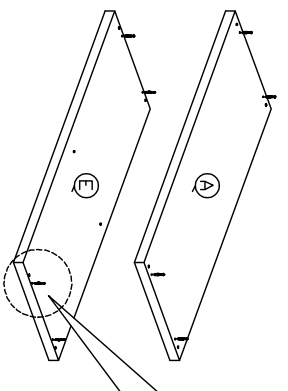

Step 5

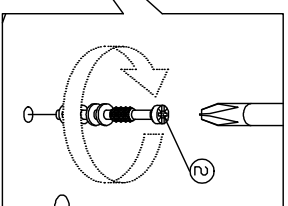
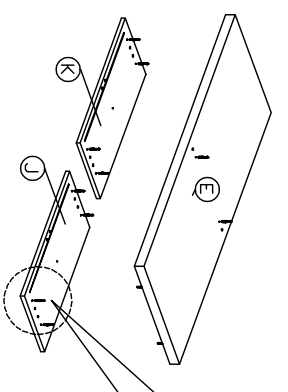

Step 6

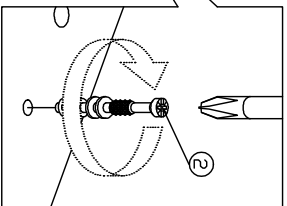
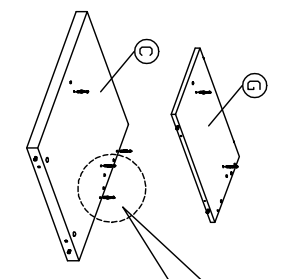

Step 7

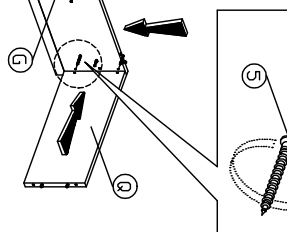
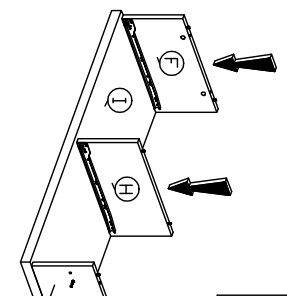

Step 8

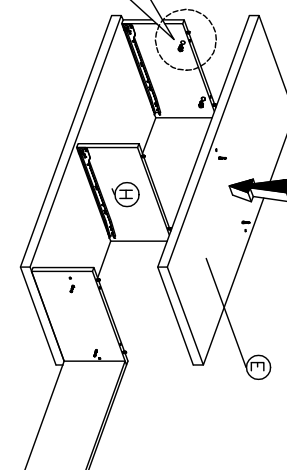
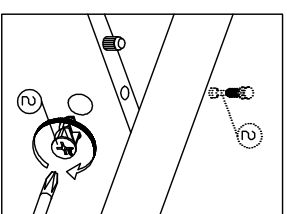

Step 9

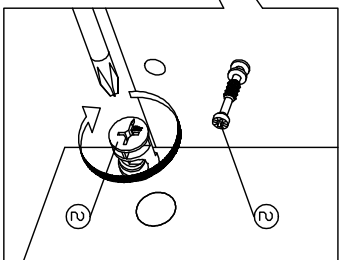
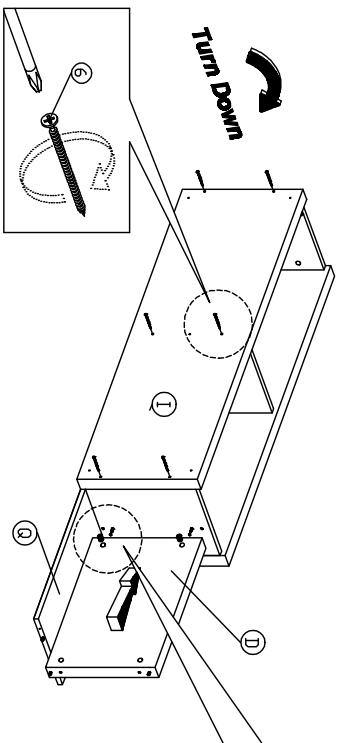

Step 10

